

Study of Tri-level Neutral Point Clamped Inverter for 3-Phase 3-Wire and 3-Phase 4-Wire Applications

Man-Chung Wong^{1,2}, Ning-Yi Dai¹, Ying-Duo Han^{1,2}

¹Faculty of Science and Technology, Department of Electrical and Electronics Engineering, University of Macau, Macao, S. A. R. , P. R. China

²Department of Electrical Engineering, Tsinghua University, Beijing, P. R. China

Abstract—In this paper, the theoretical differences and similarities of Tri-level Neutral-Point-Clamped Inverters in 3-phase 3-wire and 3-phase 4-wire systems are studied. In the past researches, almost all the studies of Tri-level NPC Inverter are focused on the 3-phase 3-wire applications. However, more flexible application strategy can be taken in the Tri-level NPC Inverter Structure. With the connection of neutral wire and mid-point of d. c. linked capacitors of Tri-level inverter, it turns into 3-Phase 4-Wire Operation. In this paper, more detailed discussion is performed. Simulation and experimental results are given accordingly.

Keywords—Power Quality Compensation, Tri-level Inverter, 3 Dimensional Pulse-Width-Modulation

I. INTRODUCTION

The 3-Phase 4-Wire Inverter Topology [1] can be mainly classified into 4-Leg configuration and 3-Leg Center-Split structure. However, according to the past comparisons and discussions of the 2-Level 3-Phase 4-Wire Inverters, the 3-Leg Center-Split structure has following drawbacks: Complicated Control Strategy, D. C. Linked Voltage Variation and Lower D. C. Voltage Utility Ratio [2]. However, the above conclusion is valid only for 2 Level Inverter Structures, but not the Tri-level Neutral-Point-Clamped system [3]. The convenient and flexible structure can be received if Tri-level NPC Inverter is in applications of 3-Phase 3-Wire and 3-Phase 4-Wire Systems. It is obvious that when a wire is connected between the mid-point of d. c. linked capacitors of Tri-level NPC inverter and the neutral wire of 3-Phase 4-Wire system, Tri-level NPC Inverter is in 3-Phase 4-Wire Operation. Without the neutral wire connection, it turns into a 3-Phase 3-Wire System. No further adaptation of the Tri-level NPC Inverter's circuit configuration is needed. Besides, the d. c. voltage utilization ratios of Tri-level NPC Inverters for 3-Phase 3-Wire and 3-Phase 4-Wire cases will be the same. No matter it is 3-phase 3-wire or 3-phase 4-wire system, Tri-level NPC Inverter is suffered from the d. c. voltage variation issue. Due to the above consideration, Tri-level NPC Inverter may be a good strategy in the applications for 3-Phase 3-Wire and 3-Phase 4-Wire Systems. In this paper, the theoretical differences and similarities of Tri-level NPC Inverters in 3-phase 3-wire and 3-phase 4-wire systems are studied. Simulation and experimental results are given accordingly in this paper.

II. CIRCUIT CONFIGURATION

Fig. 1 shows the structure of Tri-level Neutral Point Clamped Inverter for 3-Phase 3-Wire System. Referring to Fig. 2, a 3-phase 4-wire 2-level center-split inverter is shown. In Fig.2, a wire is connected between the mid-point of d.c. side and the neutral wire of the system, it turns into a 3-phase 4-wire system. However, according to this structure and comparing with 4-arm structure for 3-phase 4-wire system, the d.c. voltage utility ratio is reduced into half of 4-arm case, and d.c. linked voltage variation is occurred. Based on the above analysis for 2-level system, there are a lot of researches [2] focusing on the 4-arm structure for 3-phase 4-wire applications.

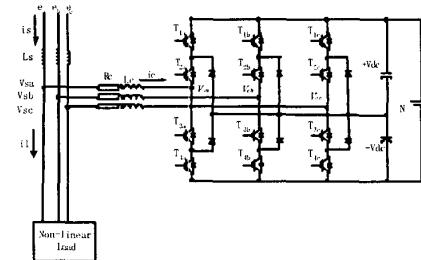

Fig. 1 Tri-Level NPC Inverter Structure for 3-Phase 3-Wire System

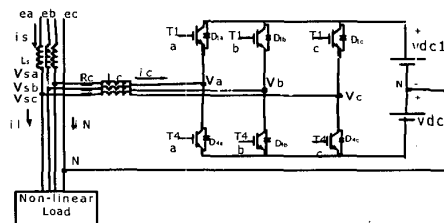

Fig.2 Two-Level Center-Split 3-Phase 4-Wire Inverter

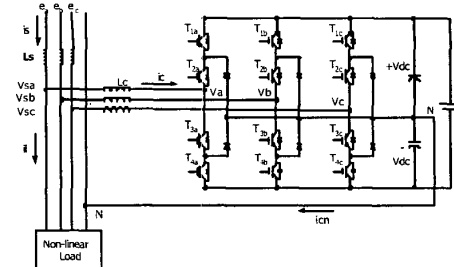

Fig. 3 Tri-level NPC 3-Phase 4-wire Inverter

Further consideration is taken for Tri-level NPC system. It is obvious that when a wire is connected between the mid-point of d. c. linked capacitors of Tri-level NPC inverter and the neutral wire of 3-Phase 4-Wire

system, Tri-level NPC Inverter is in 3-Phase 4-Wire Operation. Fig. 3 shows the circuit configuration of Tri-level NPC 3-Phase 4-Wire System. Furthermore, 3-phase 3-wire and 3-phase 4-wire systems have the same d.c. voltage utility ratio and d.c. voltage variation issue.

III. 3-PHASE 3-WIRE AND 3-PHASE 4-WIRE CONTROL STRATEGIES AND THEIR DC VOLTAGE VARIATION ISSUES

A. Review of Traditional 3-Phase 3-Wire Tri-level NPC Inverter

In traditional 3-Phase 3-Wire Tri-Level NPC Inverter, there are totally 27 voltage space vectors, but there are only 19 available switching states. Furthermore, different voltage vector may have different effect on the d.c. voltage variation. Normally, the 3-level voltage space vectors are divided into 4 groups: Zero, Small, Medium and Large Vectors [3][4][5][6].

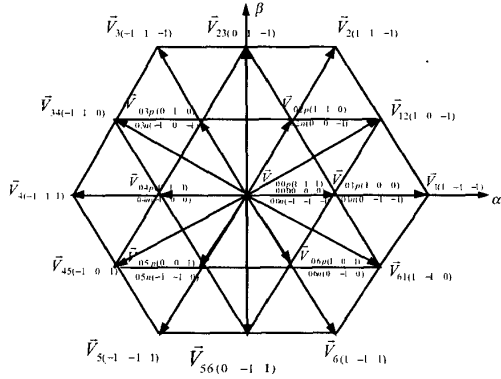

Fig. 4 Voltage Space Vector's Allocation in $\alpha\beta$ frame

Fig. 4 shows the 3-level voltage space vector's allocation in $\alpha\beta$ frame. It may be considered as the basic control scheme, 2-Dimensional PWM. Table 1 summarizes the results from [3]~[6] for those available voltage space vectors, switching patterns, vector groups, usable switching states and the d.c. voltage variation. In Table 1, the symbol "N" means that there is no effect on the d.c. voltage variation. Obviously, the vectors $\{\vec{V}_{000}, \vec{V}_{00p}, \vec{V}_{00n}\}$ do not have any influence on the d.c. voltage variation of the inverter, and they are belonged to the same group as the same available state. However, the influence of the medium vectors $\{\vec{V}_{12}, \vec{V}_{23}, \vec{V}_{34}, \vec{V}_{45}, \vec{V}_{56}, \vec{V}_{61}\}$ on the d.c. voltage variation are unknown and it depends on the connected loads and whether those 3-phase loads are balanced or not. If the connected loads on 3 phases are unknown or unpredictable, there is no way to use those vectors to control the d.c. voltage variation. Nevertheless, in small vector group, when the vector of $\{\vec{V}_{01p}, \vec{V}_{02p}, \vec{V}_{03p}, \vec{V}_{04p}, \vec{V}_{05p}, \vec{V}_{06p}\}$ is chosen, the upper d.c. side linked voltage is decreased and vice versa. By reasonable

choosing of switching vector from small-vector group, the d.c. voltage variation can be controlled.

TABLE I
SUMMARY OF 3-LEVEL NPC 3-PHASE 3-WIRE INVERTER

Vector Number	Voltage Space Vector	Switching Patterns	Group	Available State	DC Voltage Variation
1	\vec{V}_{000}	{0,0,0}	Zero	1	N
2	\vec{V}_{00p}	{1,1,1}	Zero	1	N
3	\vec{V}_{00n}	{-1,-1,-1}	Zero	1	N
4	\vec{V}_1	{1,-1,-1}	Large	2	N
5	\vec{V}_2	{1,1,-1}	Large	3	N
6	\vec{V}_3	{-1,1,-1}	Large	4	N
7	\vec{V}_4	{-1,1,1}	Large	5	N
8	\vec{V}_5	{-1,-1,1}	Large	6	N
9	\vec{V}_6	{1,-1,1}	Large	7	N
10	\vec{V}_{12}	{1,0,-1}	Medium	8	unknown
11	\vec{V}_{23}	{0,1,-1}	Medium	9	unknown
12	\vec{V}_{34}	{-1,1,0}	Medium	10	unknown
13	\vec{V}_{45}	{-1,0,1}	Medium	11	unknown
14	\vec{V}_{56}	{0,-1,1}	Medium	12	unknown
15	\vec{V}_{61}	{1,-1,0}	Medium	13	unknown
16	\vec{V}_{01p}	{1,0,0}	Small	14	Upper Decrease
17	\vec{V}_{02p}	{0,-1,-1}	Small	14	Lower Decrease
18	\vec{V}_{03p}	{1,1,0}	Small	15	Upper Decrease
19	\vec{V}_{04p}	{0,0,-1}	Small	15	Lower Decrease
20	\vec{V}_{05p}	{0,1,0}	Small	16	Upper Decrease
21	\vec{V}_{06p}	{-1,0,-1}	Small	16	Lower Decrease
22	\vec{V}_{07p}	{0,1,1}	Small	17	Upper Decrease
23	\vec{V}_{08p}	{-1,0,0}	Small	17	Lower Decrease
24	\vec{V}_{09p}	{0,0,1}	Small	18	Upper Decrease
25	\vec{V}_{10p}	{-1,-1,0}	Small	18	Lower Decrease
26	\vec{V}_{11p}	{1,0,1}	Small	19	Upper Decrease
27	\vec{V}_{12p}	{0,-1,0}	Small	19	Lower Decrease

B. Study of Tri-level NPC 3-Phase 4-Wire Inverter

According to circuit configuration of 2-Level Center-Split Inverter in Fig. 2, it is obvious that the Tri-level NPC inverter can be classified as one of the Center-Split Inverters so that only a wire is connected with the neutral ground of 3-Phase 4-Wire System from the mid-point of Tri-level NPC Inverter as shown in Fig. 3. The Tri-Level

NPC Inverter can be operated in 3-Phase 4-Wire Case. So, the Tri-level NPC Inverter can be considered as a flexible circuit configuration for 3Phase 3-Wire and/or 4-Wire System.

The control strategy can be performed by 3-dimensional techniques in $\alpha\beta 0$ frame, such as the 3D Cubical Hysteresis, Cylindrical Coordinate Controls and 3D Space Vector Modulation [7][8][9]. Equation (1) expresses the transformation from abc into $\alpha\beta 0$ frame. Conventionally, the zero-frame is not included in the transformation. However, zero-frame is needed for neutral wire voltage or current control in 3-phase 4-wire system.

$$\begin{bmatrix} v_\alpha \\ v_\beta \\ v_0 \end{bmatrix} = \sqrt{\frac{2}{3}} \begin{bmatrix} 1 & -\frac{1}{2} & -\frac{1}{2} \\ 0 & \frac{\sqrt{3}}{2} & -\frac{\sqrt{3}}{2} \\ \frac{1}{\sqrt{2}} & \frac{1}{\sqrt{2}} & \frac{1}{\sqrt{2}} \end{bmatrix} \begin{bmatrix} v_a \\ v_b \\ v_c \end{bmatrix} \quad (1)$$

Based on (1), switching function and consideration of equivalent circuit of Tri-level NPC Inverter, shown in Fig. 5, the mathematical model of 3D voltage space vector can be constructed as (2). Switching function can be $S_j \in \{-1, 0, 1\}$ in 3-level, where j can be a, b or c. V_{dc} is assumed to be $V_{dc} = V_{dc1} = V_{dc2}$.

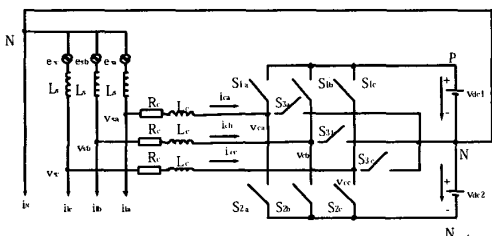

Fig. 5 Equivalent Circuit of Tri-Level NPC 3-Phase 4-Wire Inverter

$$\vec{v} = V_{dc} \left[\sqrt{\frac{2}{3}} S_\alpha \cdot \vec{n}_\alpha + \frac{1}{\sqrt{2}} S_\beta \cdot \vec{n}_\beta + \frac{1}{\sqrt{3}} S_0 \cdot \vec{n}_0 \right] \quad (2)$$

, where

$$S_\alpha = S_a - \frac{1}{2} S_b - \frac{1}{2} S_c$$

$$S_\beta = S_b - S_c$$

$$S_0 = S_a + S_b + S_c$$

According to the above consideration, the 3 dimensional voltage space vectors can be described as shown in Fig. 6.

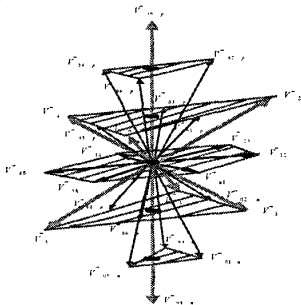

Fig. 6 3D Voltage Space Vector's Allocation

According to the d.c. voltage variation that based on the analysis of the switching state and equivalent circuit, those vectors can be classified as Larger-Than-Zero-Axis, Equal-To-Zero-Axis and Smaller-Than-Zero-Axis Vectors. In Table 2, the characteristics of Tri-Level NPC 3-Phase 4-Wire Inverter is summarized.

TABLE 2
SUMMARY OF 3-LEVEL NPC 3-PHASE 4-WIRE INVERTER

Vector Number	Voltage Space Vector	Switching Patterns	Group	Available State	DC Voltage Variation
1	\vec{V}_{000}	{0,0,0}	Equal-to-Zero	1	unknown
2	\vec{V}_{00p}	{1,1,1}	Larger-Than-Zero	2	Upper Decrease
3	\vec{V}_{00n}	{-1,-1,-1}	Smaller-Than-Zero	3	Lower Decrease
4	\vec{V}_1	{1,-1,-1}	Smaller-Than-Zero	4	Lower Decrease
5	\vec{V}_2	{1,1,-1}	Larger-Than-Zero	5	Upper Decrease
6	\vec{V}_3	{-1,1,-1}	Smaller-Than-Zero	6	Lower Decrease
7	\vec{V}_4	{-1,1,1}	Larger-Than-Zero	7	Upper Decrease
8	\vec{V}_5	{-1,-1,1}	Smaller-Than-Zero	8	Lower Decrease
9	\vec{V}_6	{1,-1,1}	Larger-Than-Zero	9	Upper Decrease
10	\vec{V}_{12}	{1,0,-1}	Equal-to-Zero	10	unknown
11	\vec{V}_{23}	{0,1,-1}	Equal-to-Zero	11	unknown
12	\vec{V}_{34}	{-1,1,0}	Equal-to-Zero	12	unknown
13	\vec{V}_{45}	{-1,0,1}	Equal-to-Zero	13	unknown
14	\vec{V}_{56}	{0,-1,1}	Equal-to-Zero	14	unknown
15	\vec{V}_{61}	{1,-1,0}	Equal-to-Zero	15	unknown
16	\vec{V}_{01p}	{1,0,0}	Larger-Than-Zero	16	Upper Decrease
17	\vec{V}_{01n}	{0,-1,-1}	Smaller-Than-Zero	17	Lower Decrease
18	\vec{V}_{02p}	{1,1,0}	Larger-Than-Zero	18	Upper Decrease
19	\vec{V}_{02n}	{0,0,-1}	Smaller-Than-Zero	19	Lower Decrease
20	\vec{V}_{03p}	{0,1,0}	Larger-Than-Zero	20	Upper Decrease
21	\vec{V}_{03n}	{-1,0,-1}	Smaller-Than-Zero	21	Lower Decrease
22	\vec{V}_{04p}	{0,1,1}	Larger-Than-Zero	22	Upper Decrease
23	\vec{V}_{04n}	{-1,0,0}	Smaller-Than-Zero	23	Lower Decrease
24	\vec{V}_{05p}	{0,0,1}	Larger-Than-Zero	24	Upper Decrease
25	\vec{V}_{05n}	{-1,-1,0}	Smaller-Than-Zero	25	Lower Decrease
26	\vec{V}_{06p}	{1,0,1}	Larger-Than-Zero	26	Upper Decrease
27	\vec{V}_{06n}	{0,-1,0}	Smaller-Than-Zero	27	Lower Decrease

In Tri-level NPC 3-Phase 4-Wire Inverter, the number of switching states is equal to the number of the available vectors. There are Larger-Than-Zero-Axis $\{ \vec{V}_{00p}, \vec{V}_2, \vec{V}_4, \vec{V}_6, \vec{V}_{01p}, \vec{V}_{02p}, \vec{V}_{03p}, \vec{V}_{04p}, \vec{V}_{05p}, \vec{V}_{06p} \}$, Equal-To-Zero-Axis $\{ \vec{V}_{000}, \vec{V}_{12}, \vec{V}_{23}, \vec{V}_{34}, \vec{V}_{45}, \vec{V}_{56}, \vec{V}_{61} \}$ and Smaller-Than-Zero-Axis $\{ \vec{V}_{00n}, \vec{V}_1, \vec{V}_3, \vec{V}_5, \vec{V}_{01n}, \vec{V}_{02n}, \vec{V}_{03n}, \vec{V}_{04n}, \vec{V}_{05n}, \vec{V}_{06n} \}$ vectors. When one of the Larger-Than-Zero-Axis vectors $\{ \vec{V}_{00p}, \vec{V}_2, \vec{V}_4, \vec{V}_6, \vec{V}_{01p}, \vec{V}_{02p}, \vec{V}_{03p}, \vec{V}_{04p}, \vec{V}_{05p}, \vec{V}_{06p} \}$ is chosen, $v_{dc1} < v_{dc2}$ will occur and vice versa. However, if the one of the Equal-To-Zero Vectors is activated, the d.c. voltage variation cannot be known.

C. Similarities and Differences of Tri-level NPC 3-Phase 3-Wire and 3-Phase 4-Wire Inverters

Tri-level NPC Inverter can operate as 3-Phase 3-Wire or 3-Phase 4-Wire Operation; it depends on whether the neutral wire is connected with the mid-point of the capacitors, shown in Fig. 3.

There are 27 switching vectors in a Tri-level inverter; however, there are only 19 available states in 3-Phase 3-Wire case. On the other hand, there are 27 switching states in 3-Phase 4-Wire one. Furthermore, the control strategies should be extended from 2-dimensional situation ($\alpha\beta$ frame) into 3-dimensional space ($\alpha\beta 0$ frame). Besides, the different switching state may activate different d.c. voltage variation, such as summarized in Table 1 and Table 2.

In Tri-level NPC 3-Phase 3-Wire Inverter, only vectors $\{ \vec{V}_{000}, \vec{V}_{00p}, \vec{V}_{00n}, \vec{V}_1, \vec{V}_2, \vec{V}_3, \vec{V}_4, \vec{V}_5, \vec{V}_6 \}$ cannot take any influence on the d.c. voltage variation. If only the above vectors are activated in all control periods, there is no need to consider the d.c. voltage variation in Tri-level NPC 3-Phase 3-Wire Inverter. On the other hand, there is no the case in Tri-level NPC 3-Phase 4-Wire Inverter, all the switching vectors will affect the d.c. voltage variation.

In order to control the tendency of d.c. voltage variation, the p-type or n-type vectors can be chosen. The p-type vectors can be defined as $\vec{V}_{01p}, \vec{V}_{02p}, \vec{V}_{03p}, \vec{V}_{04p}, \vec{V}_{05p}, \vec{V}_{06p}$. Besides, the n-type vectors are $\vec{V}_{01n}, \vec{V}_{02n}, \vec{V}_{03n}, \vec{V}_{04n}, \vec{V}_{05n}, \vec{V}_{06n}$. When the p-type vector is activated, the voltage of the upper arm d.c. capacitor will trend to be decreased, and vice versa. No matter it is 3-phase 3-wire or 3-phase 4-wire Tri-level NPC Inverter, the activation of p-type vector will decrease the voltage of the upper arm d.c. capacitor, and the activation of n-type vector will increase the voltage of the upper arm d.c. capacitor. However, the $\vec{V}_{12}, \vec{V}_{23}, \vec{V}_{34}, \vec{V}_{45}, \vec{V}_{56}$ and \vec{V}_{61} vectors cannot be employed to control the tendency of d.c. voltage variation in 3-phase 3-wire or 3-phase 4-wire system.

D. d.c. Voltage Variation

If the d.c. side voltage turns to be unbalance, there are 2 cases needed to be considered: the waveform quality of the inverter's output and the safety operation of the inverter. For the first issue, the waveform quality can be improved by following approach for 3-phase 4-wire system. When $v_{dc1} \neq v_{dc2}$, the V_{dc} can be redefined as (3) so that the new switching function can be expressed as (4) for upper and lower arms respectively.

$$V_{dc} = \frac{v_{dc1} + v_{dc2}}{2} \quad (3)$$

$$S_j^N = \begin{cases} v_{dc1}/V_{dc}, & \text{upper arm} \\ -v_{dc2}/V_{dc}, & \text{lower arm} \end{cases} \quad (4)$$

Substitute (3) into (4), equation (5) can be obtained. It is obvious that when the d.c. voltage is changed, the value of switching function can be changed too. The switching function can be larger than or less than 1 when the d.c. voltage is varied.

$$S_j^N = \begin{cases} 1 + \Delta S, & \text{upper arm} \\ -1 + \Delta S, & \text{lower arm} \end{cases} \quad (5)$$

, where $\Delta S = \frac{v_{dc1} - v_{dc2}}{2V_{dc}}$ and $j = a, b$ or c .

Equation (5) is in abc frame and can transferred into $\alpha\beta 0$ frame by (1) so that (6), (7) and (8) can be received.

$$S_\alpha^N = S_\alpha \quad (6)$$

$$S_\beta^N = S_\beta \quad (7)$$

$$S_0^N = S_0 + 3\Delta S \quad (8)$$

From the above equations, it can be concluded that the d.c. voltage variation will only influence the zero switching function. Substitute (5) into (2), equation (9) can be received.

$$\vec{v}^N = \vec{v} + \vec{v}_0^N \quad (9)$$

where $\vec{v}_0^N = \sqrt{3}V_{dc}\Delta S \cdot \vec{n}_0$.

According to the above discussion, if the d.c. side voltage is changed, voltage vector reference should be altered accordingly in order to reduce the affect of the voltage variation so as to improve the output waveform quality. In Tri-level NPC 3-phase 4-wire system, the zero frame is included in the calculation by 3D techniques. However, in Tri-level 3-phase 3-wire system, zero-frame is not included in the PWM calculation so that p-type and n-type vectors should be chosen in order to reduce the d.c. voltage variation so as to improve the waveform quality.

For the second issue, the safety operation of inverter should be considered due to the d.c. voltage unbalance. If voltage of one arm of the d.c. side capacitor is too large, the IGBTs or the capacitors may reach the maximum limit of rated voltage so as to destroy the components of inverter. The vectors in Table 1 and Table 2 should be chosen accordingly for 3-phase 3-wire and 3-phase 4-wire systems respectively in order to

control the d.c. voltage variation. In 3-Phase 4Wire Inverter, the Larger-Than-Zero-Axis vectors should be chosen in order to control the tendency of upper-arm d.c. voltage variation to be decreasing.

IV. SIMULATION RESULTS

The control strategy of 3DSVM for 3-arm center-split inverter is out of the discussion in this paper. And there are numerous simulated and experimental results had been performed for Tri-Level NPC 3-Phase 3-Wire Inverter so that there is no result about it in the following sections. The simulated results show that the output waveform quality can be improved by the above proposed strategy in Section III. D.

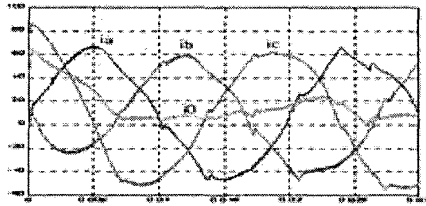

Fig. 7 Compensation Result without the Consideration of d.c. Voltage Variation

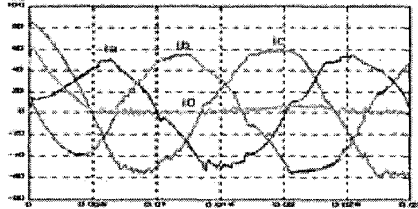

Fig. 8 Compensation Result with the Consideration of d.c. Voltage Variation

Fig. 7 shows that the a,b,c and neutral wire currents after compensation when the d.c. voltage variation is out of consideration into the vector reference. In the Fig. 7 and Fig. 8, the upper-arm d.c. voltage is reduced into 30 % of its original value, besides the lower-arm d.c. voltage of inverter is increased up to 70% of its normal value respectively. Fig. 8 shows that the output waveform quality can be improved if the vector reference in zero-axis is altered according to the d.c. voltage variation.

V. EXPERIMENTAL RESULTS

A Tri-level NPC 3-phase 4-wire inverter prototype is implemented. The control strategy is performed by 3DSVM with 5KHz switching frequency. The DSP Controller is chosen as TMS320F2407. The value of d.c. side capacitor is 10mF. The system configuration is as shown in Fig. 9.

The experimental results show that the Tri-level NPC Inverter can be operated as the 3phase 4wire power quality compensator to reduce the harmonics, unbalance and neutral currents.

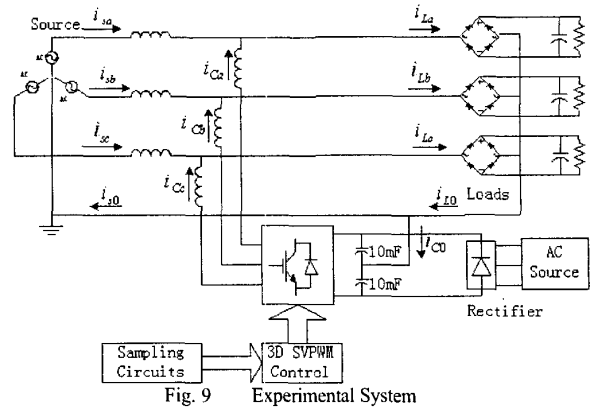

Fig. 9 Experimental System

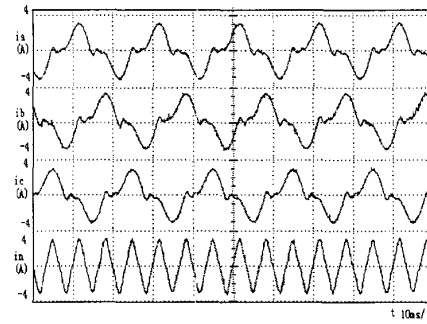

Fig. 10 Current Waveforms before Compensation

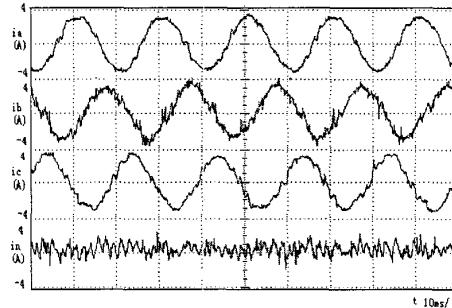

Fig. 11 Current Waveforms after Compensation

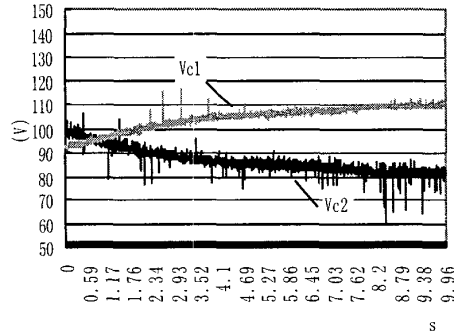

Fig. 12 d.c. Voltage Variation without Control

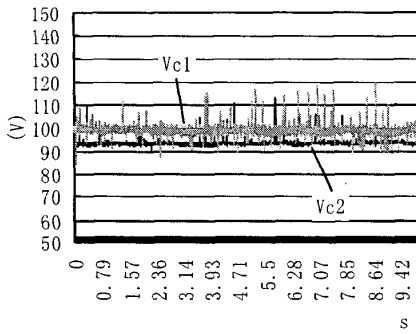

Fig. 13 d.c. Voltage Variation with Control

Fig. 10 and Fig. 11 show the a, b, c and neutral wire currents before compensation and after compensation respectively. Fig. 12 shows the d.c. side capacitor voltage variation without control. However, when the Larger-Than-Zero-Axis or Smaller-Than-Zero-Axis vectors are chosen for compensation according to the change of d.c. voltage, the d.c. capacitor voltage variation can be controlled as the experimental result shown in Fig. 13.

VI. CONCLUSION

In this paper, the theoretical difference and similarity of Tri-Level NPC Inverters operating in 3-Phase 3-Wire and 3-phase 4-Wire systems are discussed. It shows that the same circuit configuration of Tri-Level NPC Inverter can be employed for 3-Phase 3-Wire and 3-phase 4-Wire systems. With only a wire to be connected between the mid-point of capacitors of Tri-level NPC Inverter and neutral wire of system, the inverter can turn into 3-phase 4-wire operation.

In Tri-level NPC 3Phase 3-Wire Inverter, some of the vectors, $\{\vec{V}_{000}, \vec{V}_{00p}, \vec{V}_{00n}, \vec{V}_1, \vec{V}_2, \vec{V}_3, \vec{V}_4, \vec{V}_5, \vec{V}_6\}$, cannot take any influence on the d.c. voltage variation. On the other hand, there is no such case in Tri-level NPC 3Phase 4-Wire Inverter, all the switching vectors will affect the d.c. voltage variation.

In order to control the tendency of d.c. voltage variation, the p-type, $\{\vec{V}_{01p}, \vec{V}_{02p}, \vec{V}_{03p}, \vec{V}_{04p}, \vec{V}_{05p}, \vec{V}_{06p}\}$, or n-type, $\{\vec{V}_{01n}, \vec{V}_{02n}, \vec{V}_{03n}, \vec{V}_{04n}, \vec{V}_{05n}, \vec{V}_{06n}\}$, vectors can be chosen. When the p-type vector is activated, the voltage of the upper arm d.c. capacitor will tend to be decreased, and vice versa. No matter it is 3-phase 3-wire or 3-phase 4-wire Tri-level NPC Inverter, the activation of p-type vectors will decrease the voltage of the upper arm d.c. capacitor, and the activation of n-type vectors will increase the voltage of the upper arm d.c. capacitor. However, the $\vec{V}_{12}, \vec{V}_{23}, \vec{V}_{34}, \vec{V}_{45}, \vec{V}_{56}$ and \vec{V}_{61} vectors cannot be employed to control the tendency of d.c. voltage variation in 3-phase 3-wire or 3-phase 4-wire Tri-level NPC Inverter. In 3-Phase 4Wire Tri-Level NPC Inverter, the Larger-Than-Zero-Axis Vectors or Smaller-Than-Zero-

Axis Vectors can be chosen to control the tendency of d.c. voltage variation accordingly. The output waveform quality can be improved by consideration of zero-axis of the vector reference in the control strategy due to the d.c. voltage variation for 3-Phase 4-Wire System.

ACKNOWLEDGMENT

The authors would like to thank you for the financial supports of Research Committee of University of Macau and Tsinghua University.

REFERENCES

- [1] Mauricio Aredes, Jurgen Hafner, Klemens Heumann, "Three-Phase Four-Wire Shunt Active Filter Control Strategies," IEEE Trans. on Power Electronics, March 1997, Vol. 12, No. 2, pp. 311-318.
- [2] Richard Zhang, V. H. Prasad, D. Boroyevich, F.C. Lee. "Three-Dimensional Space Vector Modulation for Four-Leg Voltage-Source Converters," IEEE Trans. On Power Electronics, May 2002, Vol. 17, No. 3, pp. 314-326.
- [3] A. Nabae, I. Takahashi, H. Akagi. "A New Neutral Point Clamped PWM Inverter," IEEE Trans. on Industry Applications, Sep./Oct., 1981, Vol. 17, No. 5, pp. 518-523.
- [4] K. R. M. N. Ratnayake, Y. Murai, T. Watanabe. "Novel PWM Scheme to Control Neutral Point Voltage Variation in Three-Level Voltage Source Inverter," IEEE Industry Applications Conference, IEEE Thirty-Fourth IAS Annual Meeting, Conference Record, 1999, Volume: 3, pp. 1950 -1955.
- [5] Yo-Han Lee, Bun-Seok Suh, Dong-Seok Hyun. "A Novel PWM Scheme for a Three-Level Voltage Source Inverter with GTO Thyristor System," IEEE Trans. on Industry Application, March/April, 1996, Vol. 32, No. 2, pp. 260-268.
- [6] Haoran Zhang, Annette von Jouanne, Shaoran Dai, Alan, K. Wallace, Fei Wong. "Multilevel Inverter Modulation Schemes to Eliminate Common-Mode Voltages," IEEE Trans. on Industry Application, Nov./Dec., 2000, Vol. 36, No. 6, pp. 1645-1653.
- [7] Man-Chung Wong, Zheng-Yi Zhao, Ying-Duo Han, Liang-Bing zhao. "3-Dimensional Pulse Width Modulation Technique in 3-Level Power Inverters for 3-Phase 4Wired System," IEEE Transactions on Power Electronics, May 2001, Vol. 16, No. 3, pp.418-427.
- [8] Man-Chung Wong, Jing Tang, Ying-Duo Han. "Cylindrical Coordinate Control of 3-Dimensional PWM Technique in 3-Phase 4Wired Tri-Level Inverter," IEEE Transactions on Power Electronics, Jan. 2003, Vol. 18, No. 1, pp. 208-220.
- [9] Man-Chung Wong, Jing Tang, Ying-Duo Han. "Fundamental study of 3 dimensional pulse width modulation," International Conference on Power System Technology, POWERCON 2002, Oct. 13-17, pp. 560-564.